

QUICK START

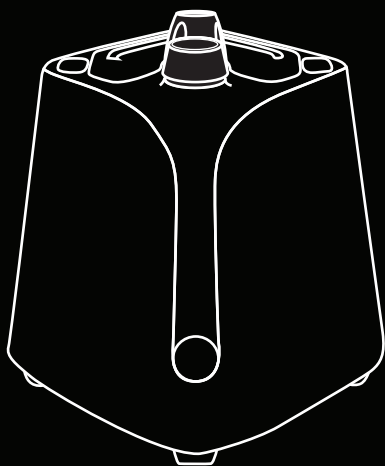

SteamOne

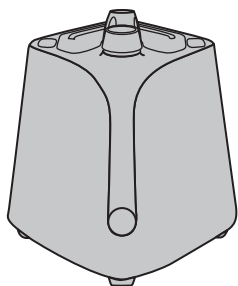

a



b



c

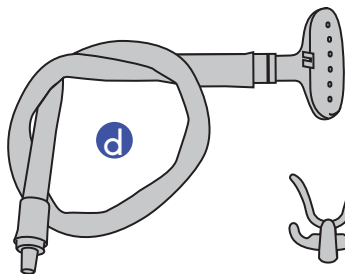

d



e

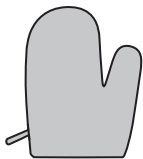

f

SteamOne

1

a + c

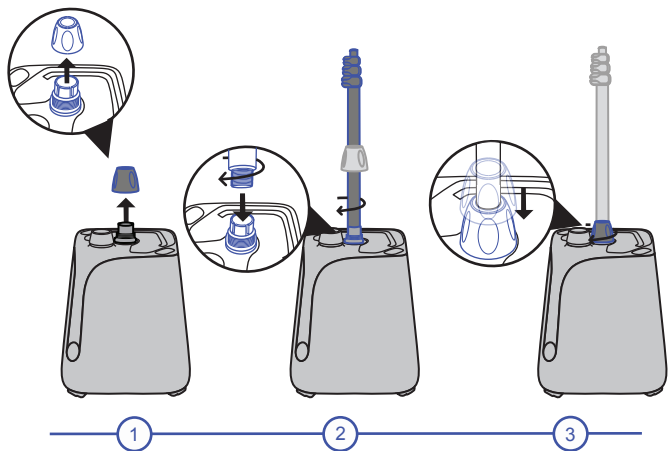

SteamOne

2

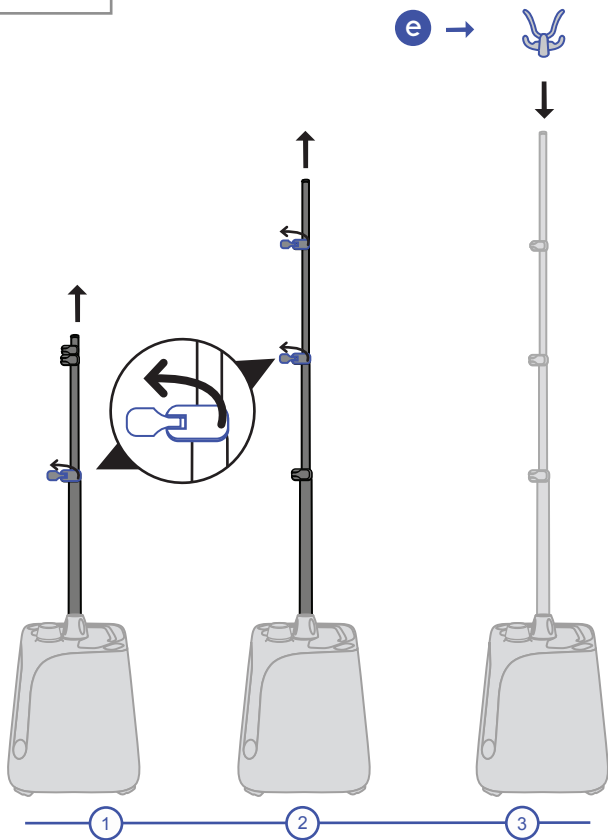

SteamOne

4

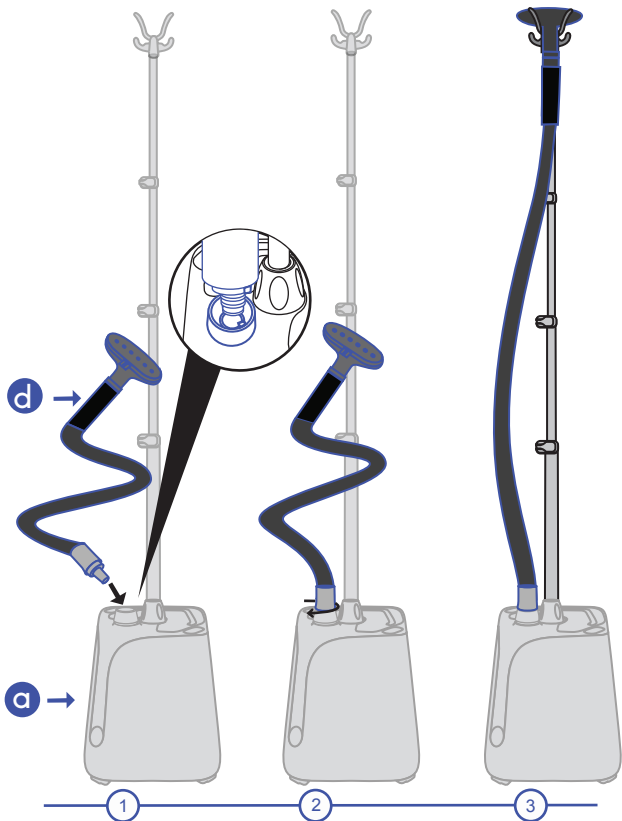

SteamOne

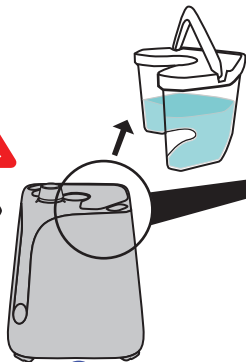
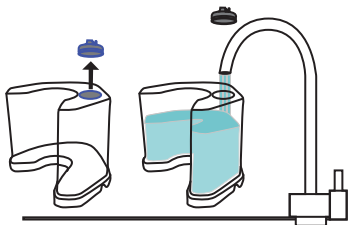
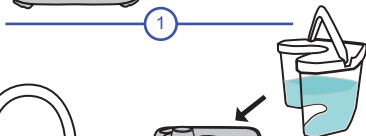

SteamOne

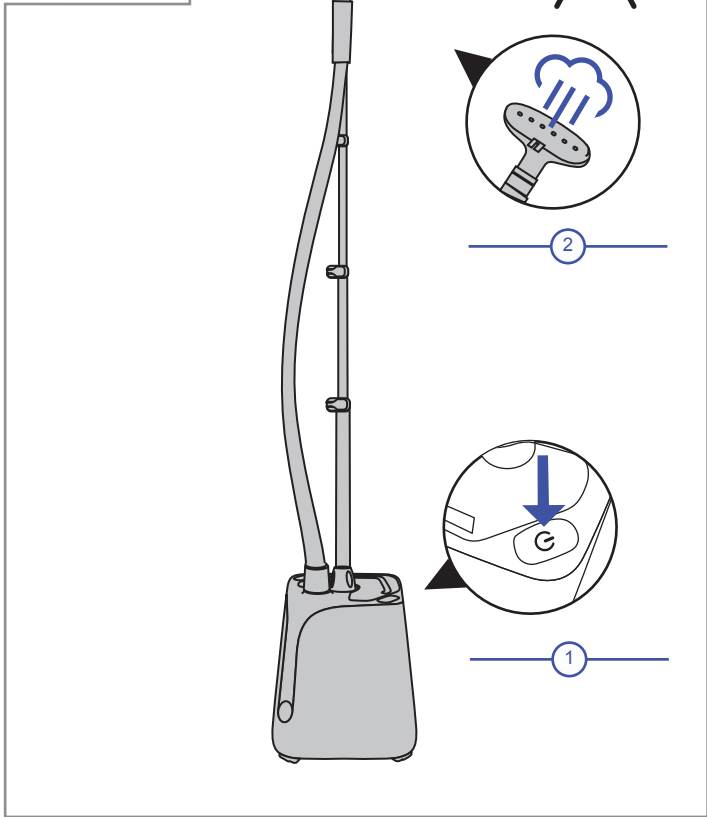

SteamOne

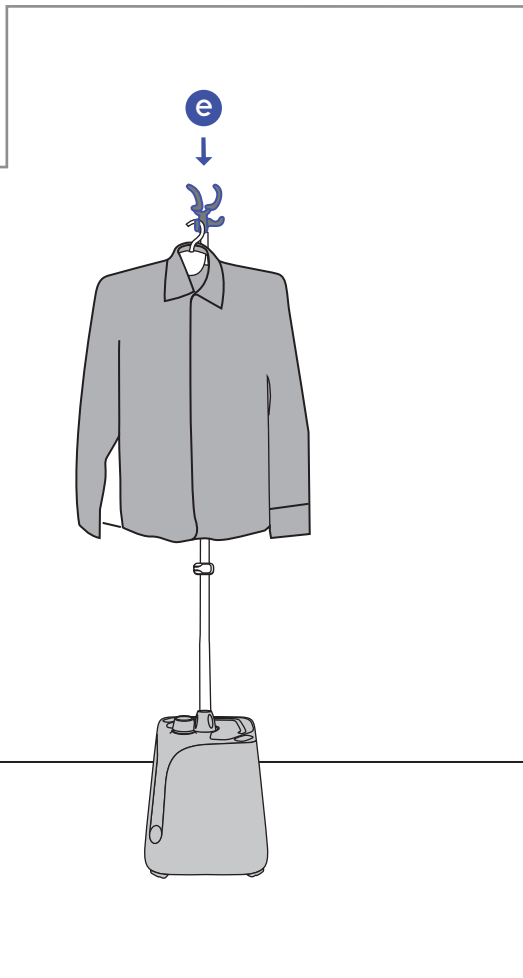

SteamOne

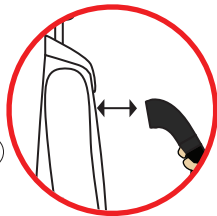

1



2

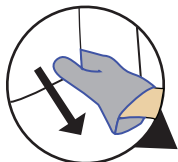

3

SteamOne

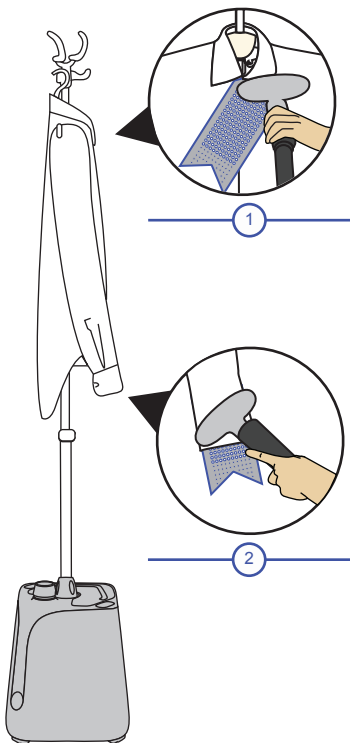
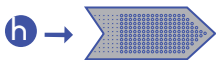

SteamOne

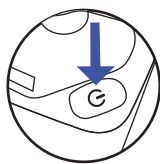

OFF

0

a →

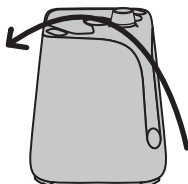

1

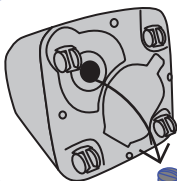
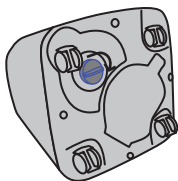

2

b →

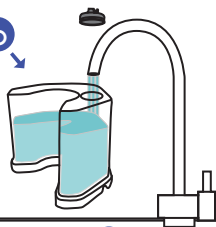

3

SteamOne

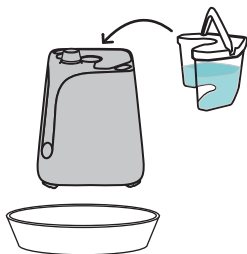

4

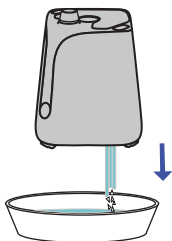

5

